

Product Brochure For L201

## AL-1324 - Centre Lathe

Ø330 x 600mm Turning Capacity - Ø40mm Spindle Bore



**Ex GST**                      **Inc GST**  
**\$11,290.00**    **\$12,419.00**

ORDER CODE:	L201
MODEL:	AL-1324
Swing Over Bed (mm):	330
Distance Between Centres (mm):	600
Spindle Bore (mm):	40
Swing In Gap (mm):	~
Swing Over Cross-slide (mm):	200
Digital Readout System Fitted:	Optional
Quick Change Toolpost Fitted:	Optional
Leadscrew Covers Fitted:	Yes
Taper Turning Attachment:	Optional
Coolant System:	Yes
Tool Height To Suit (mm):	16
Centre Height (mm):	165
Spindle Nose Size or Type:	D1-4 Camlock
Bed Width (mm):	190
Headstock Spindle Taper (MT):	5
Tailstock Taper (MT):	3
Cross Slide Travel (mm):	175
Compound Slide Travel (mm):	100
Leadscrew Type:	Metric
Metric Cross Feed (X-Axis) (mm/rev):	0.034 - 0.468
Imperial Cross Feed (X-Axis) (inch/rev):	~
Metric Longitudinal Feed (Z-Axis) (mm/rev):	0.068 - 0.936
Imperial Longitudinal Feed (Z-Axis) (inch/rev):	~
Metric Thread Steps & Pitch (No. / mm):	30(0.4 - 7.0)
Imperial Thread Steps & TPI (No. / TPI):	32(4 - 56)
3 Jaw Chuck Diameter (mm):	160
4 Jaw Chuck Diameter (mm):	200
Spindle Steps / Speeds (No. / rpm):	18 (50 - 2000)
Motor Power (kW / hp):	2.25 / 3
Voltage / Amperage (V / amp):	415
Nett Weight (kg):	580

### Description

Manufactured in Taiwan

### Features

- Tool room quality precision lathe, Made in Taiwan and have been sold for over 20 years
- Gear drive headstock for quick change of spindle speeds
- Stand increasing rigidity and reducing vibration
- Precision 'V'-beds are hardened and ground, incorporating a rigid webbed casting
- Foot operated spindle brake with safety cut out switch
- Slide out front swarf tray for easy cleaning
- Chuck guard fitted with micro switch
- Leadscrew cover ensures swarf not reaching clasp nut
- Change gears for metric and imperial thread cutting
- Oil sight glass for head stock and gearbox
- Adjustable taper roller bearings support the spindle
- Overload clutch mechanism on auto power feed
- Overload protection on drive motor and coolant system
- 3HP/415V motor, 18-speed (50 - 2000rpm)
- Enclosed quick action gearbox for thread cutting and auto feeding
- Powered longitudinal and cross feeds

## Product Brochure For L201

- D1-4 camlock spindle for quick chuck changes and safe reverse-direction turning. ISO standard
- Dual calibrated dials
- Coolant system with flexible hose
- Slide out swarf tray

### Includes

- 3-jaw chuck with reverse jaws
- 4-jaw chuck
- Faceplate
- Fixed Steady
- Travelling steady
- Chuck guard
- Concertina leadscrew covers
- Slide out front swarf tray
- Dead centre
- Thread chasing dial
- Foot brake
- Coolant system
- Rear splash guard
- Instruction booklet

### Specific Features



Left View



Headstock



Spindle Speed Levers

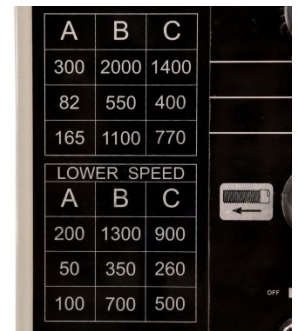

Spindle Speed Chart



Enclosed Quick Change Gearbox

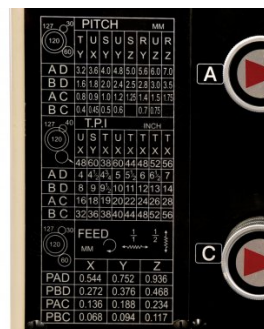

Thread-Feed Chart



Low-High Switch



Chuck Guard with Safety Micro



Safety Chuck Guard Up



Foot Brake



Sliding Drip Tray for Swarf Removal



3 Jaw Chuck

Product Brochure For L201



Fixed and Travelling Steadies



Leadscrew Cover Front

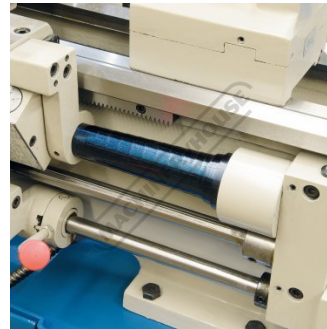

Leadscrew Cover Rear



Flexible Coolant Hose

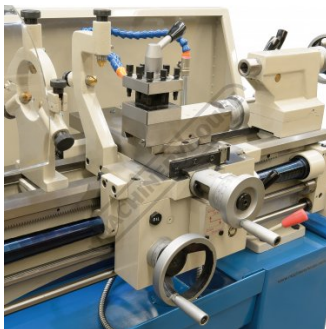

Saddle Left View

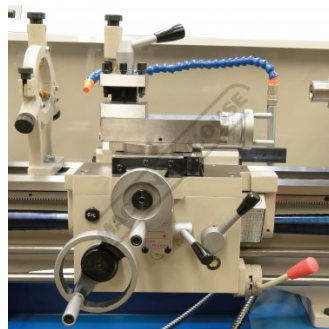

Saddle Front View



Saddle Right View

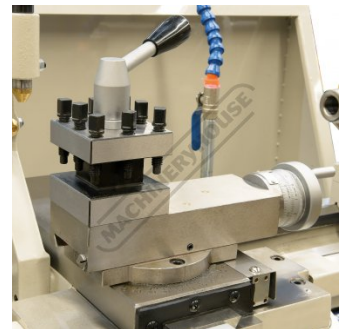

4-Way Toolpost



Thread Chasing Dial

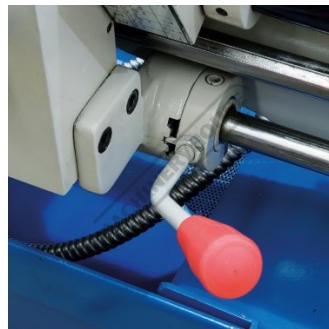

Forward Reverse Spindle Lever



Feed Levers



Swivel Compound Slide



Cross Slide Hand Wheel

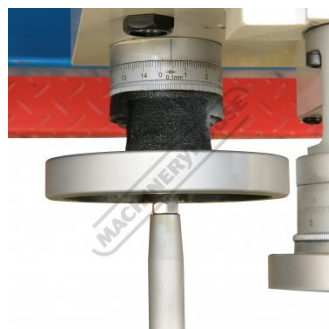

Saddle Hand Wheel

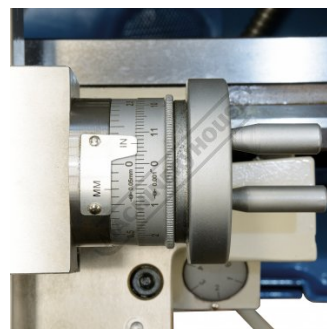

Compound Slide Hand Wheel

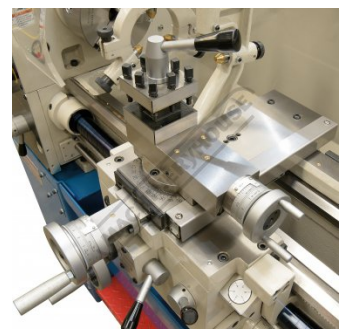

Compound Slide

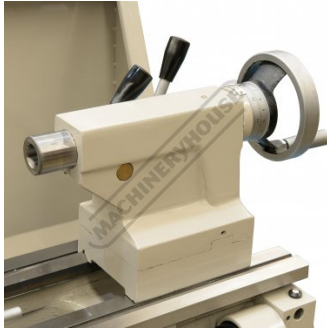

Tailstock

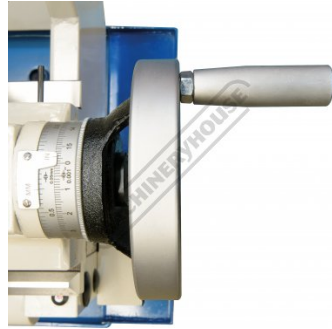

Tailstock Hand Wheel



Tailstock Quill Graduations



Tailstock Horizontal Adjustment



Hardened and Ground Bedways



Bed Drip tray



Toolbox

**Recommended Accessories**

L201D  
 Centre Lathe

D7142  
 2-Axis Digital Readout Counter -  
 1µm or 5µm

D719  
 150mm Easson Digital Readout  
 Scale

D734  
 900mm Easson Digital Readout  
 Scale



Product Brochure For L201

**L258**  
Taper Turning Attachment



**L277**  
Vertical Mill Slide



**C980**  
5C Collet Lathe Adaptor



**L295**  
Quick Change Toolpost



**L017**  
Right Hand Turning Tool Holder



**L018**  
Left Hand Turning Tool Holder



**L044**  
Right Hand Turning Tool Holder



**L045**  
Left Hand Turning Tool Holder



**L0077**  
Lathe Turning Tool Kit - 7 piece  
Insert Type



**L451**  
Lathe Turning Tool Kit - 3 piece  
Insert Type



**L457**  
Lathe Threading Tool Kit - Insert  
Type



**L465**  
Professional Lathe Parting Tool  
Kit - Insert Type



Product Brochure For L201

C052  
 3MT Live Centre



C045  
 3MT Pipe Centre - 70° Cone



L076  
 Knurling Tool Holder Kit



C290  
 Heavy Duty Drill Chuck - Keyed Type



C294  
 Industrial Drill Chuck - Keyless Type



D443A  
 3MT x JT3 Drill Chuck Arbor



D126  
 Metric Precision HSS Drill Set - 170 Pieces



D1282  
 Imperial Precision HSS Drill Set - 29 Piece



S090A  
 Soluble Metal Cutting Fluid - 1 Litre



S090  
 Soluble Metal Cutting Fluid - 5 Litre



S076  
 Cutting Tool Lubricant Fluid - 500ml



S077  
 Drilling, Tapping & Cutting Tool Lubricant Spray - 400g



Product Brochure For L201

**S075**  
Cutting Tool Lubricant Paste -  
200g



**S074**  
Cutting Tool Lubricant Paste -  
500g



**L341**  
Fitting and Machining Technical  
Book

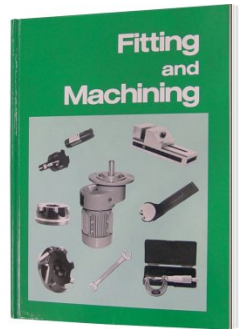

**L3455**  
Professional Sheet Metal  
Fabrication Book

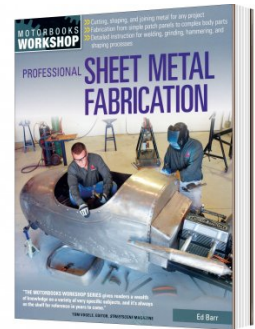

**L300**  
Magnetic Swarf Remover



**M9991**  
Magnetic Floor Sweeper



**M800**  
Rubber Mat - Anti-Fatigue



**M805**  
Rubber Mat - Anti-Fatigue

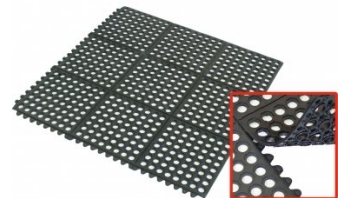

**O000**  
SpillFix Universal Organic  
Absorbent



**O000A**  
Natural Zeolite Absorbent



**O043**  
Rust & Corrosion Preventive -  
Penetrant & Lubricant



**O042**  
General Purpose Lubricant &  
Corrosion Inhibitor



Product Brochure For L201

---

O040

Rust & Corrosion Preventive -  
Penetrant & Lubrication



O044

Rust & Corrosion Preventive -  
Penetrant & Lubrication

