

## C910 - ER32 Collet

Ø10-Ø9mm  
 "Made in Taiwan"

**Ex GST**  
**\$24.00**

**Inc GST**  
**\$26.40**



ORDER CODE:	C910
Type:	ER32
Metric Size (mm):	10 - 9
Imperial Size (inch):	~



### Features

- Manufactured to DIN standard
- Collet size covers a range from expanded to compressed
- Collets from 2mm have 1mm of movement
- Collets are listed by their expanded size
- Eg. When ordering an ER32-3 the range is from 3mm expanded to 2mm compressed

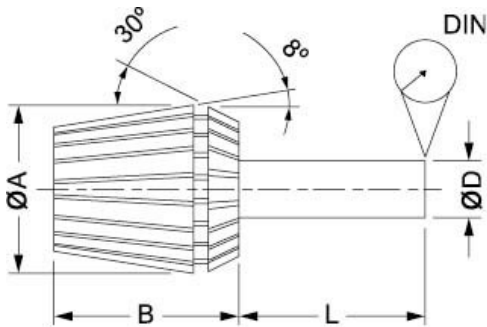

Collet	A	B	L	DIN	RANGE (D)
ER11	11.5	18	6	0.02	0.5-7.0
ER16	17	27	10	0.02	0.5-10.0
ER20	21	31	16	0.02	1.0-13.0
ER25	26	35	25	0.02	1.0-16.0
ER32	33	40	40	0.02	2.0-20.0
ER40	41	46	50	0.03	3.0-26.0

**Installation Guide** - Please see downloads for full details

**1.**

**2.**

**3.**

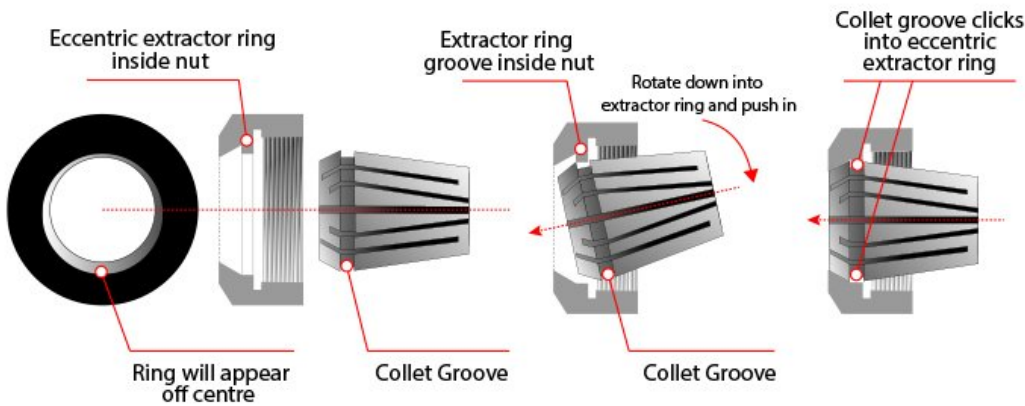

**Recommended Accessories**

C921  
ER32 Collet Set - 6 Piece

C922  
ER32 Collet Set - 18 Piece

C9245  
Collet & Chuck Set - 8 Piece

C925  
Collet & Chuck Set - 8 Piece



Product Brochure For C910

**C926**  
Collet & Chuck Set - 20 Piece



**C927**  
Collet & Chuck Set - 20 Piece



**C928**  
Collet & Chuck Set - 20 Piece



**C929**  
Collet & Chuck Set - 20 Piece



**C929A**  
Collet & Chuck Set - 20 Piece



**C931**  
32 x 100 x ER32 Collet Chuck -  
Straight



**C105**  
Collet Chuck - 3MT x ER32



**C106**  
Collet Chuck - R8 x ER32



**C110**  
Collet Chuck - NT30 x ER32



**C112**  
Collet Chuck NT40 - ER32



**T332**  
BT30 x ER32-60 Collet Chuck



**T220**  
BT40 x ER32-70 Collet Chuck



Product Brochure For C910

sales@machineryhouse.com.au  
www.machineryhouse.com.au

T224

BT40 x ER32-100 Collet Chuck

T448

BT50 x ER32-100 Collet Chuck

T007

BT40 x ER32 Floating Tap Holder

T008

ER32 x 32 x 100 Floating Tap Holder

