

C8551 - ER25 Collet

Ø3-Ø2mm
 "Made in Taiwan"

Ex GST
\$22.00

Inc GST
\$24.20



ORDER CODE:	C8551
Type:	ER25
Metric Size (mm):	3 - 2
Imperial Size (inch):	~



Features

- Manufactured to DIN standard
- Collet size covers a range from expanded to compressed
- Collets from 2mm have 1mm of movement
- Collets are listed by their expanded size
- Eg. When ordering an ER32-3 the range is from 3mm expanded to 2mm compressed

Product Brochure For C8551

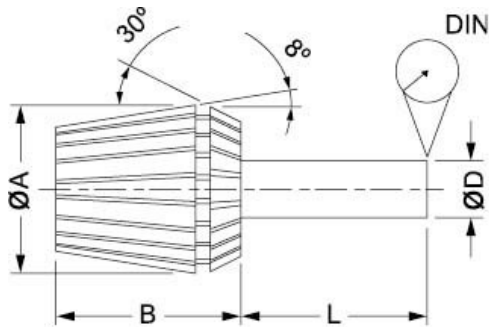

Collet	A	B	L	DIN	RANGE (D)
ER11	11.5	18	6	0.02	0.5-7.0
ER16	17	27	10	0.02	0.5-10.0
ER20	21	31	16	0.02	1.0-13.0
ER25	26	35	25	0.02	1.0-16.0
ER32	33	40	40	0.02	2.0-20.0
ER40	41	46	50	0.03	3.0-26.0

Installation Guide - Please see downloads for full details

1.

2.

3.

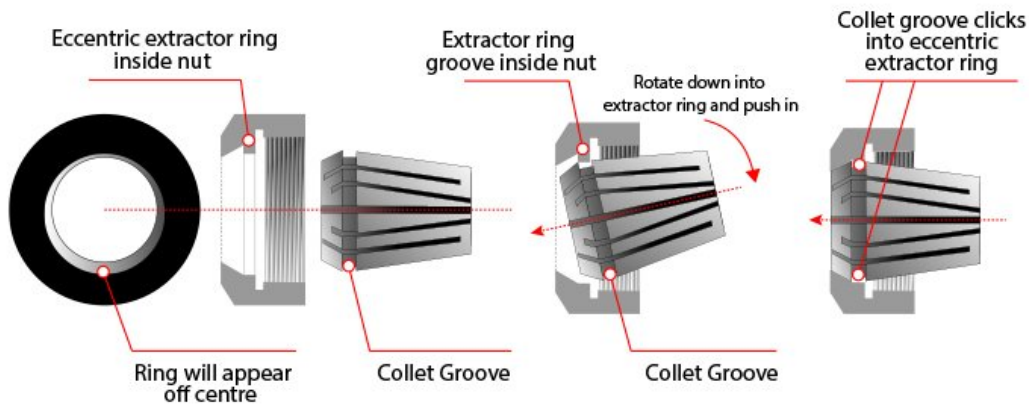

Recommended Accessories

C860
ER25 Collet Set - 15 Piece

C864
25 x 150 x ER25 Collet Chuck - Straight

C861
ER25 Collet Chuck Wrench

T214
BT40 x ER25-70 Collet Chuck



Product Brochure For C8551

sales@machineryhouse.com.au
www.machineryhouse.com.au

T215

BT40 x ER25-100 Collet Chuck

