

C905 - ER32 Collet

Ø5-Ø4mm
 "Made in Taiwan"

Ex GST
\$24.00

Inc GST
\$26.40



ORDER CODE:	C905
Type:	ER32
Metric Size (mm):	5 - 4
Imperial Size (inch):	~



Features

- Manufactured to DIN standard
- Collet size covers a range from expanded to compressed
- Collets from 2mm have 1mm of movement
- Collets are listed by their expanded size
- Eg. When ordering an ER32-3 the range is from 3mm expanded to 2mm compressed

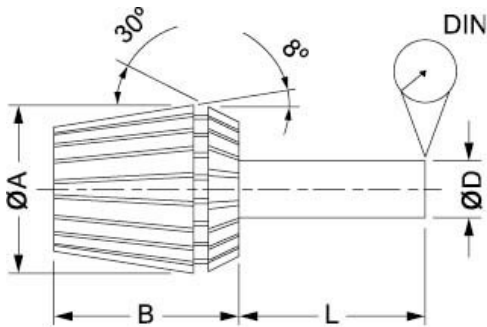

Collet	A	B	L	DIN	RANGE (D)
ER11	11.5	18	6	0.02	0.5-7.0
ER16	17	27	10	0.02	0.5-10.0
ER20	21	31	16	0.02	1.0-13.0
ER25	26	35	25	0.02	1.0-16.0
ER32	33	40	40	0.02	2.0-20.0
ER40	41	46	50	0.03	3.0-26.0

Installation Guide - Please see downloads for full details

1.

2.

3.

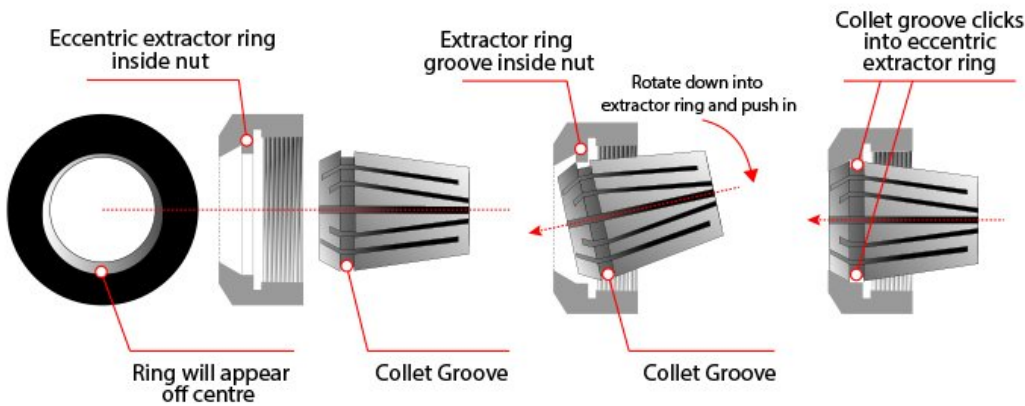

Recommended Accessories

C921
ER32 Collet Set - 6 Piece

C922
ER32 Collet Set - 18 Piece

C9245
Collet & Chuck Set - 8 Piece

C925
Collet & Chuck Set - 8 Piece



Product Brochure For C905

C926
Collet & Chuck Set - 20 Piece



C927
Collet & Chuck Set - 20 Piece



C928
Collet & Chuck Set - 20 Piece



C929
Collet & Chuck Set - 20 Piece



C929A
Collet & Chuck Set - 20 Piece



C931
32 x 100 x ER32 Collet Chuck -
Straight



C105
Collet Chuck - 3MT x ER32



C106
Collet Chuck - R8 x ER32



C110
Collet Chuck - NT30 x ER32



C112
Collet Chuck NT40 - ER32



T332
BT30 x ER32-60 Collet Chuck



T220
BT40 x ER32-70 Collet Chuck



Product Brochure For C905

sales@machineryhouse.com.au
www.machineryhouse.com.au

T224

BT40 x ER32-100 Collet Chuck

T448

BT50 x ER32-100 Collet Chuck

T007

BT40 x ER32 Floating Tap Holder

T008

ER32 x 32 x 100 Floating Tap Holder

