

Product Brochure For S9715

SPB-40125 - CNC Synchro Pressbrake

4000 X 125T CYBELEC TOUCH DRAW - 5 AXIS
 Includes Programmable Y1, Y2, X, V & R-Axis & Laser Guarding

Coming Soon

Ex GST

Inc GST

\$86,950.00 \$95,645.00



ORDER CODE:	S9715
MODEL:	SPB-40125
Control Unit (Type):	CYBELEC TOUCH 12
Nominal Pressure - Tonnage (Ton):	125
Nominal Pressure - Kilonewtons (kN):	1250
Length of Work Table (mm):	4000
Distance Between Columns (mm):	3355
Throat Depth (mm):	350
Maximum Open Height (mm):	455
Ram Stroke (mm):	200
Machine Axis (No.):	5
Safety Guarding System (Type):	Laser System
Ballscrew Backgauge Travel (mm):	600
Leadscrew Backgauge Travel:	~
Table Bed Crowning System (Type):	CNC Controlled System
Motor Power (kW / hp):	11 / 15
Motor Voltage (V):	415
Floor Space Requirements (L x W x H) (mm):	~
Nett Weight (kg):	7800



Description

CYBELEC CybTouch CNC Controller

The CybTouch 12 is specifically developed for synchronised press brakes, Headquartered in Switzerland Cybelec is at the forefront of pressbrake controller technology.

The control features an intuitive interface with an advanced array of bending functions with vivid colour & large touch key interactive touch software. Interactive On-line help, and many other automatic functions that constantly guide the operator. CybTouch controllers are very easy to operate.

METALMASTER Synchro Pressbrake

The Metalmaster Synchro series pressbrakes adopt a heavy duty integral welded steel structure that is furnace tempered post welding to relieve residual stresses and ensure accuracy & longevity of the machine.

The hydraulic cylinders are manufactured from high resistance steel incorporating chromium plated ground & lapped pistons to ensure longevity of the Swedish brand SKF hydraulic seals

The hydraulics system consists of electronically controlled proportional valves with independent 3 point closed loop safety monitoring of the two cylinders as well as the main hydraulic system.

Italian manufactured DSP Laser Guarding ensures operator safety whilst in operation. The Laser system is designed to cater for many different types and sizes of top tooling ensuring safety at the appropriate points as required by the AUS/NZ standards.

At the heart of the electrical system is the Italian made MCS safety control module which controls & monitors all pressbrake functionality, the MCS provides dual monitoring & closed loop feedback for all critical safety functions such as Hydraulic valves, Emergency stop circuits, doors, guards, foot pedal, DSP lasers to name a few functions. This ensures the machinery to be Compliant with AS/NZS 4024.1 – 2019 Safety of Machinery Series

Features

- CYBELEC CybTouch CNC Controller
- Large, vivid and high-contrast fully touchscreen control mounted on a swivel pendant for optimal ergonomics
- Simple pages, clear display, large keys
- Intuitive 2D graphical touch draw part profile programming with auto bend sequencing
- Bend material allowance calculation
- Radius bump bending calculation function
- Angle, pressure and crowning calculation & management

Product Brochure For S9715

- bending angle and back gauge correction
 - Various automatic calculations of other bend functions
 - Complete programming for efficient mass production with multiple bends
 - Bending sequences and programs can be saved for future use
 - Easy single bends with EasyBend page
 - Easy manual movement
 - On-line help and interactive warning pop-ups
- METALMASTER Synchro Pressbrake
 - 5 CNC Controlled Axis (Y1, Y2, X, R, V) as standard.
 - Y1 & Y2 Axis is controlled by advanced safety monitored hydraulic proportional valves ensuring accuracy in movement.
 - Bending compensation & accuracy is maintained using GIVI (Italy) Linear scales mounted on either end of the machine bed to measure any frame deflection
 - CNC controlled auto crowning table (V) adjusts accordingly based on material, length & thickness specified in program.
 - Servo driven X & R Axis provides fast response & accuracy when positioning the backgauge.
 - X-Axis Linear guides & ball screws (Taiwan) / R-Axis rack & pinion
 - X axis travel 600mm - Speed = 200 mm/s
 - R axis travel 150mm - Speed = 100 mm/s
 - Flip up type back gauge fingers mounted on linear rails complete with micro adjusters are provided as standard
 - Advanced push button quick release tooling top clamps allow for the top tooling to be removed from the front of the clamp rather than sliding all of the tooling left & or right, this saves time and ensures you are not shifting all your tooling just to change 1 piece.
 - Premium front sheet supports, fully adjustable in the vertical direction & mounted on linear rails for ease of use.
 - Mild steel capacity is rated on hot rolled material with 250MPA

Includes

- CYBELEC Touch 12 2D Graphical CNC Control
- Touch draw profile programming with Auto bend sequence function
- Easy bend function for quick one off jobs even if you are in the middle of a production bending program
- Quick release top tool clamping system with advanced front load tooling system
- 86 Degree Top Punch with Segments & Horns (4 x 800mm, 1 x Segmented 800mm comprising of Left Horn 100, 10, 15, 20, 40, 50, 165, 300, Right Horn 100)
- Multi V bottom die block 95 x 95mm with a range of V's between 4mm~65mm
- DSP Safety laser guard system
- MCS safety control for safety compliance & peace of mind

Specific Features



Front



Enclosed Rear Safety Guarding



Servo X-R Axis Back Gauge

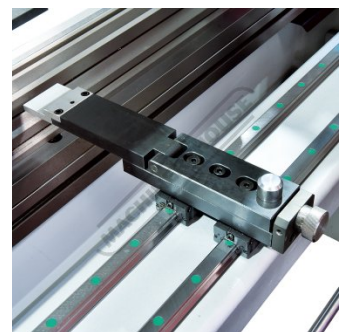

Micro Adjustment Backstop

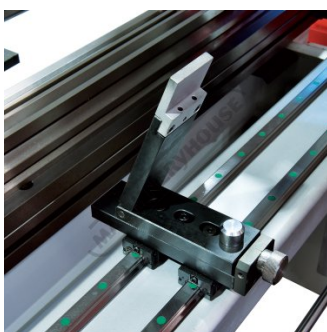

Flip Up Backstop



Laser Guarding System with Alignment Guide

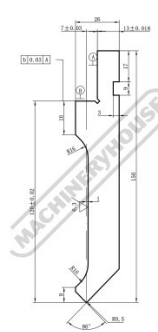

86 Degree Top Punch

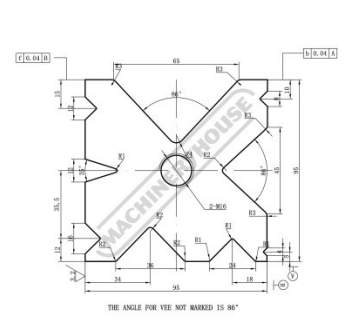

Multi V Die Block - 4mm~65mm

Product Brochure For S9715



Multi V Die Block



Adjustable Sliding Front Sheet Supports



Quick Release Tool Clamps - Change Tools without sliding them all out



CNC Table Crowning



Electrical Panel



Cyb Touch12 CNC Control



Main Screen

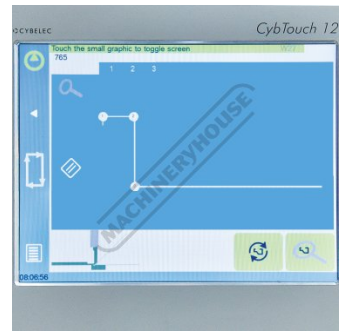

Touch Draw Graphical Programming



Bend Simulation 1



Bend Simulation 2



Bend Options



Bend Program List



Easy Bend Page

Recommended Accessories

S991
 86° Top Punch Pressbrake Tooling



S991S
 86° Top Punch Pressbrake Tooling - Segmented



S993A
 95mm Die Block Pressbrake Tooling

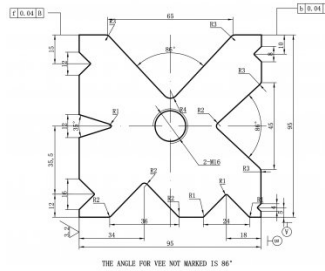

S990
 35° Top Punch Pressbrake Tooling



S990S
 35° Top Punch Pressbrake Tooling - Segmented



S997
 15° Top Punch Pressbrake Tooling



S997A
 60mm Die Block Pressbrake Tooling



S997B
 60mm Die Rail Pressbrake Tooling

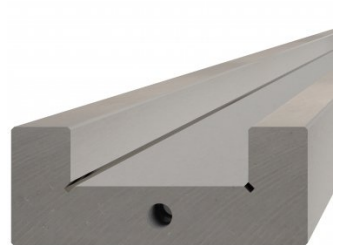

Product Brochure For S9715

sales@machineryhouse.com.au
www.machineryhouse.com.au

Q201
Universal Bevel Protractor

Q2015
Universal Dial Bevel Protractor

M800
Rubber Mat - Anti-Fatigue

M805
Rubber Mat - Anti-Fatigue

