

Product Brochure For P9024

Swiftcut PRO 2500WT - CNC Plasma Cutting Table

2500 x 1250mm Water Table System
 Hypertherm Powermax125 - Cuts up to 25mm Mild Steel Plate

Ex GST **Inc GST**
\$48,700.00 **\$53,570.00**

ORDER CODE:	P9024
MODEL:	Swift-Cut PRO 2500WT
Cutting Table Capacity (mm):	2500 x 1250
Cutting Capacity - Mild Steel (mm):	25
Plasma Cutting Unit:	Powermax 125
Current Output (amp):	30 - 125
Duty Cycle (Typical):	100% @ 125A
Fume Management (Type):	Water Tray System
Cutting Gas (Type):	Air
Plasma Unit Input Voltage (V):	415V
Machine Input voltage:	-
Plasma Unit Input Amperage (amp):	36
Nett Weight (kg):	1000



Description

With a 2500 x 1250mm cutting area, the Swift-Cut PRO 2500 is a feature packed plasma cutting table with the ability and power to cut for as long as required. With a robust steel fully welded frame and free standing operators console, making it ideal for workshops, metal fabricators, educational establishments, designers and artists.

With gantry parking to allow a full sheet to be loaded overhead and a dropped rail for ease of loading, not to mention the simple on-going maintenance, the Swift-Cut PRO 2500 really is the answer to all your cutting needs.

SOFTWARE: Standard Version

- Auto Arc voltage capture and regulation to automatically adjust the cut settings to suit varied material characteristics
- Program recovery function automates starting part way through a program
- Sheet Trim function to easily trim off excess skeleton
- G code browser & editor for the novice operator
- G code favourites – user customised
- DXF, DWG & JPEG photo import function
- 3D part Viewer
- Advanced importer with ability to re-export and save the filtered DXF
- 5 user assigned reference points for jigs and fixtures
- Sheet rotation function
- Automatic lead in / out of cut paths
- Dry run capability for testing prior to cutting
- Parametric shapes library with over 80 shapes
- Automatic cutting consumable recommendations based on material and thickness
- Manual nesting of parts
- Team viewer software for remote support

SOFTWARE: Advanced Version (Optional Extra)

- All of the Standard version features
- Automatic nesting parts for economical sheet usage
- Automatic Part in part nesting - Nests parts in scrap areas to fully utilise sheet

HYPERTHERM PLASMA:

Delivering maximum power and performance for air plasma, the Powermax125® plasma system cuts thick metals fast. Able to make short work of the toughest cutting jobs the system offers a 100% duty cycle @ 25 mm mechanized pierce capability

Features

Product Brochure For P9024

- Fully fabricated and welded steel frame
- Water tray for efficient control of sparks and fumes with removable stainless steel splash guards for side rail protection
- Dropped rails for ease of loading full sheets
- Gantry parking to allow full sheet to be loaded overhead
- Linear guideways for fast accurate motion
- High speed axis motors with closed loop feedback (encoder) for accuracy and reliability
- Dual motor drive Y-axis
- Rack and pinion drive system
- 360 Degree Breakaway head eliminates damage to torch and improves safety
- Laser guide for easy sheet positioning
- Free-Standing Operators Console with LCD TOUCHSCREEN control
- Cut metal up to 25mm thick depending on the Hypertherm Powermax unit selected
- Soft sense Digital Torch-Height Control (DTHC) Quick response for improved cut quantity and improved torch consumable life. This unique touch sensing is so soft and accurate even the thinnest sheet metal will not deflect while sensing.
- Dynamic Cut Control (DCC) is available on all Swiftcut PRO machines, This feature enables Software control of cutting amps and air pressure, Error messages, air pressures and critical data from the plasma unit is displayed on Swiftcut control screen for operator convenience, On the fly arc voltage, air pressure and cutting speed control ensures the highest quality cut at all times. INDUSTRY 1st UNIQUE TO SWIFT-CUT

Optional Accessories

- SwiftMark marker unit - Integrated pneumatic marker. Can be used to automatically mark text, fold lines and centre marks on components prior to profiling to avoid costly second operations. Great for part numbering or serial numbering of parts.
- Advanced upgrade - Swiftcam software upgrade

Specific Features



Pro 2.5m Made In UK



Console



Initial Height Sense

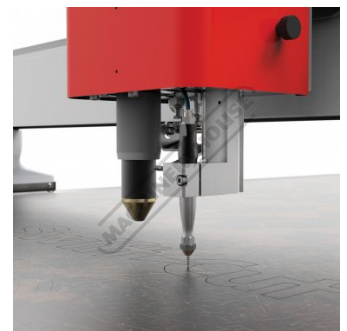

Optional Engraver Shown



Head Gantry



Gantry Safety-Cover



Linear Rail Rack-Side

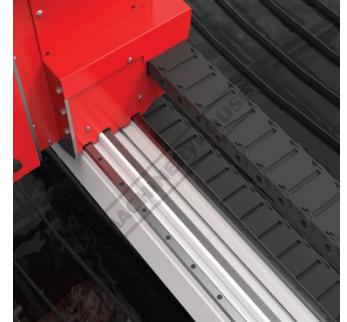

Side Rail Head

Product Brochure For P9024



Supplied With Powermax125

Recommended Accessories

P9056
 SwiftCAM Advanced Software Upgrade



Software solutions for programming plasma cutting machines

P9064
 Swift-Marker Pro 2020



P799
 Plasma Water Table Fluid



C525
 Industrial Pilot Air Compressor



C5451
 Refrigerated Compressed Air Dryer



P849
 Hypertherm 30-125A Electrode



P850
 Hypertherm 125A Nozzle



P851
 Hypertherm 65A Nozzle



Product Brochure For P9024

P852
 Hypertherm 45A Nozzle



P853
 Hypertherm FineCut Only Nozzle



P854
 Hypertherm 125A Shield



P855
 Hypertherm 45-65A Shield



P856
 Hypertherm FineCut Only Shield



P857
 Hypertherm 125A Swirl Ring



P858
 Hypertherm FineCut Only Swirl Ring



P859
 Hypertherm 30-125A Retaining Ring Cap



AP0001
 Air filter element - Internal filter Powermax



AP0006
 Hypertherm O-Ring



AP0007
 Hypertherm O-Ring Lube



P8081
 Hypertherm Eliminer Filter - Replacement filter element



Product Brochure For P9024

sales@machineryhouse.com.au
www.machineryhouse.com.au

P8064

Hypertherm Hand Torch

