

Product Brochure For W08257

WT28-2412N - 2400 x 1200mm M28 Pro Series Welding Table

Plasma Nitriding Coating

New Release

Ex GST	Inc GST
\$8,950.00	\$9,845.00



ORDER CODE:	W08257
MODEL:	WT28-2412N
Type:	Pro Series Welding Table
Leg Frame Type:	~
Table Top Size (mm):	2400 x 1200
Table Height with Stand (mm):	~
Table Side Height (mm):	200
Top Plate Thickness (mm):	25
Grid Pattern (mm):	100 x 100
Table Hole Diameter (mm):	28
Table Slots (mm):	~
Table Load Capacity (kg):	~
Nett Weight (kg):	~

METALMASTER



Description

The Metalmaster M28 Pro Series welding tables features a welded & ribbed construction from heavy S355 plate steel, the frame is then CNC machined with the sides & top having a finished nominal thickness of 25mm. The CNC machining process is able to achieve a high flatness tolerance of +/- 0.1mm over 1m2 to give you a smooth precision welding surface. During this CNC machining process, the Ø28mm holes are precision bored to ensure a hole distance tolerance of +/- 0.05mm & with a diagonal style hole pattern it gives you a multitude of fixture holes to suit your application. Before removing the table from the machining centre, we engrave 100mm grid lines & perimeter ruler to give you millimetre precision helping you minimise mistakes while increasing productivity.

Our Pro Series able have been designed with interlocking solid steel ribs & 200mm high sides to maintain rigidity & heavy load capacity for all heavy fabrication projects. The diagonal style hole spacing is an industry standard 100 x 100mm grid with an additional hole in the centre giving you almost endless possibilities for both welding and clamping applications. The table also comes complete with heavy powder coated tube steel legs complete with heavy duty caster wheels featuring integrated levelling feet ensuring a stable working surface.

All our M28 Pro Series come standard with a plasma nitriding coating which thermochemically case hardens the surface so not only making it harder but also making it spatter, wear & rust resistant.

Choose from our wide range of optional Pro Series clamping kits & fixturing accessories to add to your table giving you the ultimate welding & fixturing system so when you go into battle with your next fabrication project it's a knockout.

Features

- Plasma nitriding surface finish for increased hardness, rust & spatter resistance
- Ø28mm Precision bored fixing holes at 100mm centres
- Diagonal hole grid pattern offering a multitude of clamping options
- 100mm grid lines & perimeter ruler engraving
- Precision CNC machined to ensure flatness of +/- 0.1mm over 1m2
- Tabletop & sides manufactured from heavy 25mm S355 plate steel

Includes

- 6pcs of heavy steel legs c/w caster with integrated leveling feet

Optional Accessories

- 42pc Welding Clamp Set (W08280)

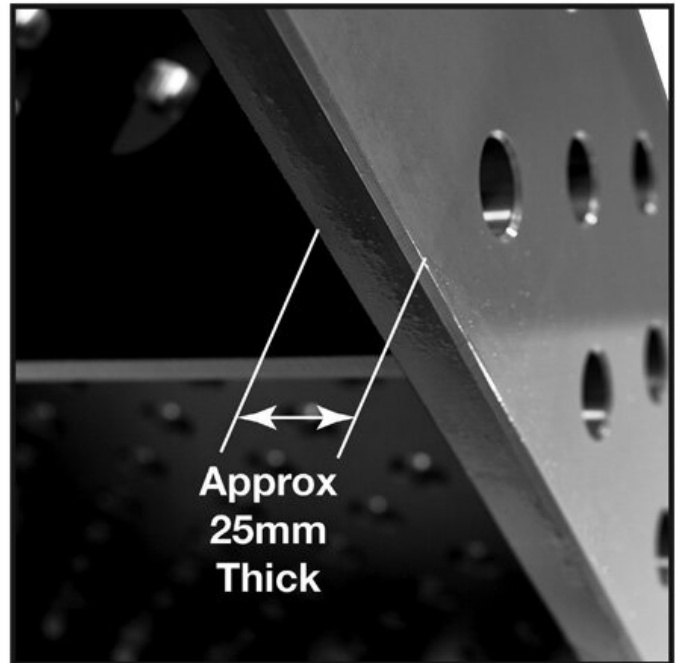
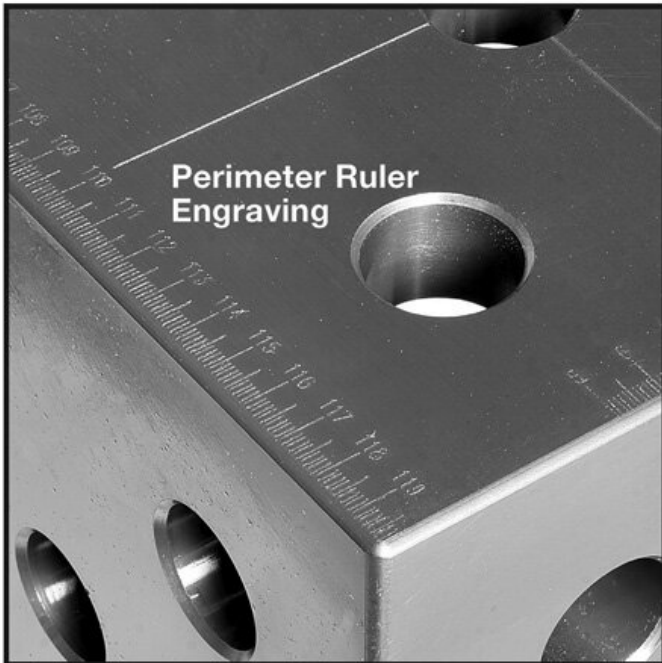
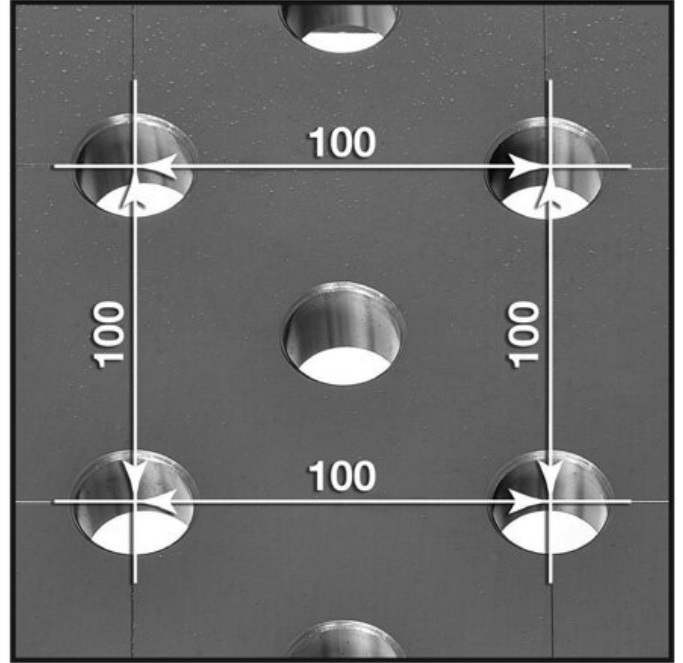
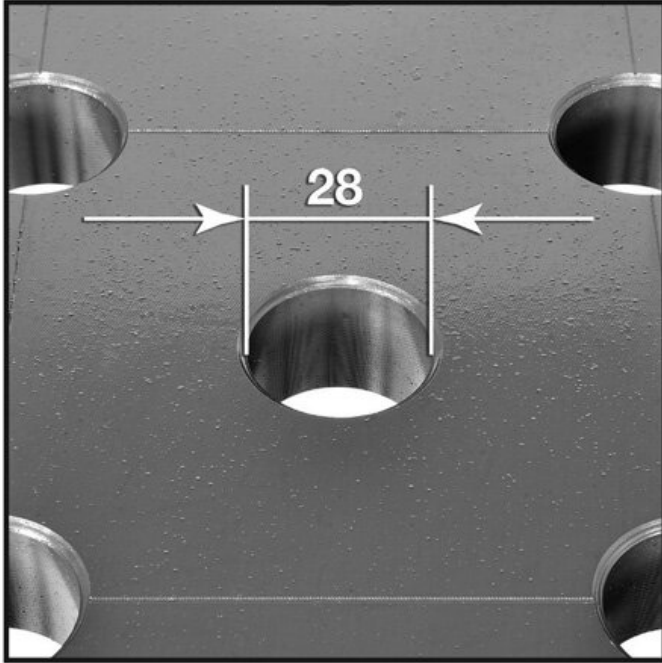

Product Brochure For W08257

Specific Features



Plasma Nitriding Surface Finish



28mm Diameter Holes

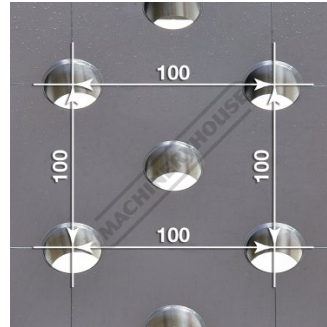

100 x 100mm Hole Centres Diagonal Pattern



Perimeter Ruler Engraving



Marked Grid Pattern

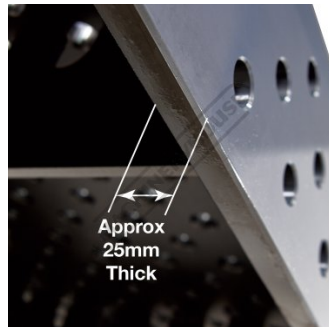

Material Thickness Approx 25mm

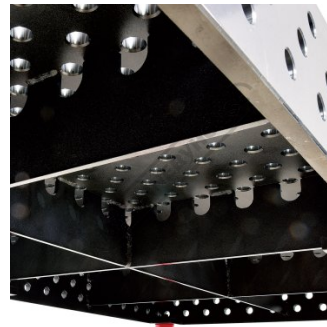

Stengthened by Welded Webbing

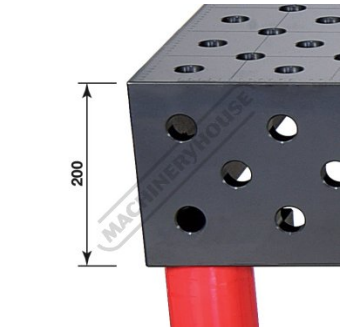

200mm Sides



Adjustable Levelling Castor



Low View

Product Brochure For W08257

Recommended Accessories

W08280

42pc Welding Table Clamping & Fixturing Kit



W08301

180 Degree Welding Table Clamp with T-Bar Handle



W08304

90 Degree Welding Table Clamp with T-Bar Handle



W08307

45 Degree Welding Table Clamp with T-Bar Handle



W08372

Countersink Ball Lock Pin 28 x 50mm



W08370

Ball Lock Pin 28 x 50mm



W08371

Ball Lock Pin 28 x 75mm



W08360

Cross V-Block with 90 & 120 Degree



Product Brochure For W08257

W08340

Straight Bar Stop 100 x 50 x 25mm



W08341

Straight Bar Stop 150 x 50 x 25mm



W08342

Straight Bar Stop 225 x 50 x 25mm



W08343

Straight Bar Stop 300 x 50 x 25mm



W08320

Angle Bracket / Stop 75 x 75 x 50mm



W08321

Angle Bracket / Stop 175 x 75 x 50mm



W08324

Angle Bracket / Stop 175 x 175 x 50mm



W08325

Angle Bracket / Stop 275 x 175 x 50mm

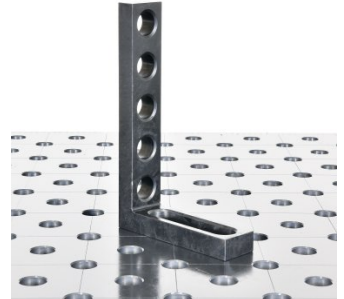

W08330

L Bracket 175 x 175 x 25mm



W08331

L Bracket 275 x 225 x 25mm



W08335

T Bracket 250 x 150 x 25mm



W08329

Adjustable Angle Bracket 500 x 100 x 100mm



Product Brochure For W08257

sales@machineryhouse.com.au
www.machineryhouse.com.au

W08326

Angle Bracket Set 300 x 275 x 100mm



W08327

Angle Bracket Set 600 x 375 x 100mm



W08350

Riser Block 500 x 200 x 200mm



W08351

Riser Block 1000 x 200 x 200mm

