

AL-1324 - Centre Lathe

Ø330 x 600mm Turning Capacity - Ø40mm Spindle Bore
 Includes Digital Readout System



Back In Stock Soon

Ex GST

Inc GST

\$12,650.00 \$13,915.00

ORDER CODE:	L201D
MODEL:	AL-1324
Swing Over Bed (mm):	330
Distance Between Centres (mm):	600
Spindle Bore (mm):	40
Swing In Gap (mm):	~
Swing Over Cross-slide (mm):	200
Digital Readout System Fitted:	Yes
Quick Change Toolpost Fitted:	Optional
Leadscrew Covers Fitted:	Yes
Taper Turning Attachment:	Optional
Coolant System:	Yes
Tool Height To Suit (mm):	16
Centre Height (mm):	165
Spindle Nose Size or Type:	D1-4 Camlock
Bed Width (mm):	190
Headstock Spindle Taper (MT):	5
Tailstock Taper (MT):	3
Cross Slide Travel (mm):	175
Compound Slide Travel (mm):	100
Leadscrew Type:	Metric
Metric Cross Feed (X-Axis) (mm/rev):	0.034 - 0.468
Imperial Cross Feed (X-Axis) (inch/rev):	~
Metric Longitudinal Feed (Z-Axis) (mm/rev):	0.068 - 0.936
Imperial Longitudinal Feed (Z-Axis) (inch/rev):	~
Metric Thread Steps & Pitch (No. / mm):	30(0.4 - 7.0)
Imperial Thread Steps & TPI (No. / TPI):	32(4 - 56)
3 Jaw Chuck Diameter (mm):	160
4 Jaw Chuck Diameter (mm):	200
Spindle Steps / Speeds (No. / rpm):	18 (50 - 2000)
Motor Power (kW / hp):	2.25 / 3
Voltage / Amperage (V / amp):	415
Nett Weight (kg):	580

Description

Manufactured in Taiwan

Features

- Tool room quality precision lathe, Made in Taiwan and have been sold for over 20 years
- 2-Axis digital readout system fitted
- Gear drive headstock for quick change of spindle speeds
- Stand increasing rigidity and reducing vibration
- Precision 'V'-beds are hardened and ground, incorporating a rigid webbed casting
- Foot operated spindle brake with safety cut out switch
- Slide out front swarf tray for easy cleaning
- Chuck guard fitted fitted with micro switch
- Leadscrew cover ensures swarf not reaching clasp nut
- Change gears for metric and imperial thread cutting
- Oil sight glass for head stock and gearbox
- Adjustable taper roller bearings support the spindle
- Overload clutch mechanism on auto power feed
- Overload protection on drive motor and coolant system

Product Brochure For L201D

- 3HP/415V motor, 18-speed (50 - 2000rpm)
- Enclosed quick action gearbox for thread cutting and auto feeding
- Powered longitudinal and cross feeds
- D1-4 camlock spindle for quick chuck changes and safe reverse-direction turning. ISO standard
- Dual calibrated dials
- Coolant system with flexible hose
- Slide out swarf tray

Includes

- 2-Axis digital readout system fitted
- 3-jaw chuck with reverse jaws
- 4-jaw chuck
- Faceplate
- Fixed Steady
- Travelling steady
- Chuck guard
- Concertina leadscrew covers
- Slide out front swarf tray
- Dead centre
- Thread chasing dial
- Foot brake
- Coolant system
- Rear splash guard
- Instruction booklet

Specific Features



Left View

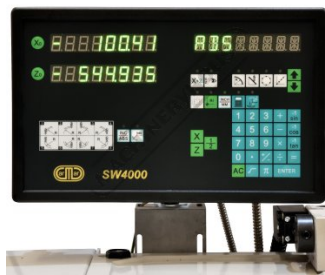

2 Axis Digital Readout



Chuck Guard with Safety Micro



Safety Chuck Guard Up



Headstock



Spindle Speed Levers



Enclosed Quick Change Gearbox

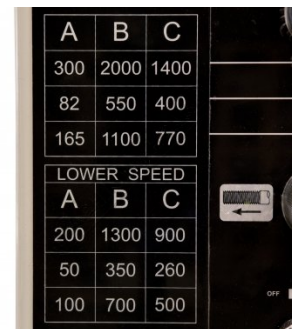

Spindle Speed Chart

Product Brochure For L201D

sales@machineryhouse.com.au
www.machineryhouse.com.au

PITCH		MM	
U	T	U	S
V	R	V	R
X	Y	X	Z
Y	Z	Y	Z
A			
AD	32	34	36
BD	16	18	20
AC	0.8	0.9	1.0
BC	0.4	0.5	0.6
B			
C			
TPI		INCH	
U	T	U	T
V	R	V	R
X	Y	X	Z
Y	Z	Y	Z
A			
AD	4	4	5
BD	8	9	10
AC	16	18	20
BC	32	36	40
B			
C			
FEED		MM	
X	Y	Z	
PAD	0.54	0.752	0.936
PBD	0.272	0.376	0.468
PAC	0.138	0.188	0.234
PBC	0.068	0.094	0.117

Thread-Feed Chart



Hi Low Switch



Foot Brake



Sliding Drip Tray for Swarf Removal



3 Jaw Chuck



Fixed and Travelling Steadies



Leadscrew Cover Front

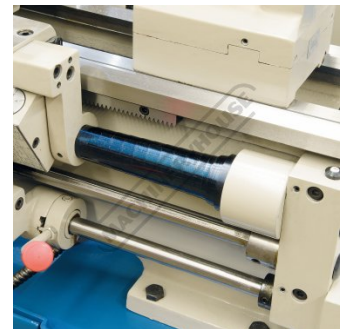

Leadscrew Cover Rear



Flexible Coolant Hose

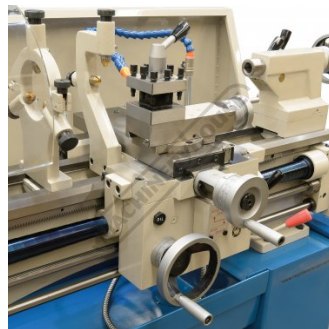

Saddle Left View

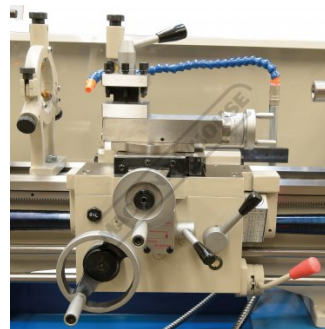

Saddle Front View

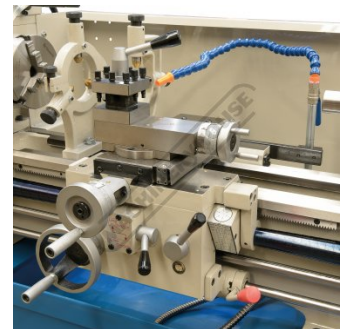

Saddle Right View

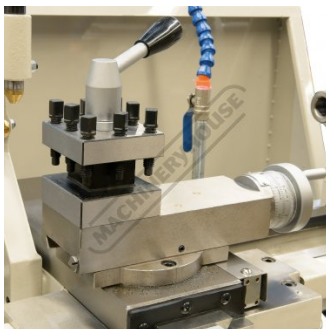

Toolpost



Thread Chasing Dial

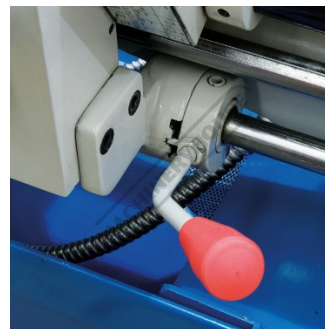

Forward Reverse Spindle Lever



Feed Levers

Product Brochure For L201D



Swivel Compound Slide



Cross Slide Hand Wheel

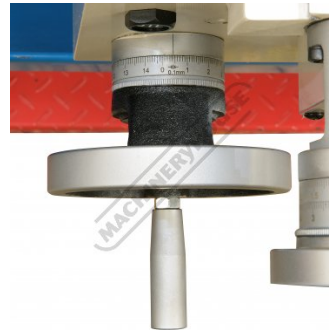

Saddle Hand Wheel

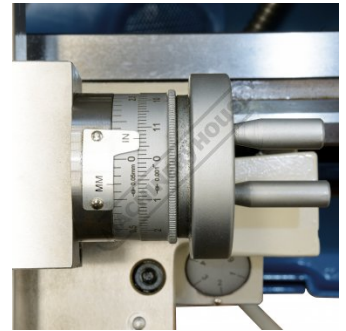

Compound Slide Hand Wheel

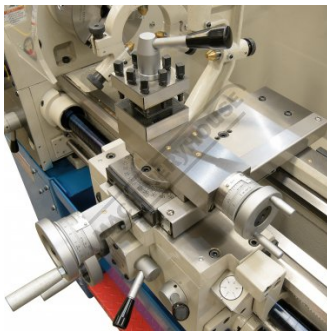

Compound Slide



Tailstock

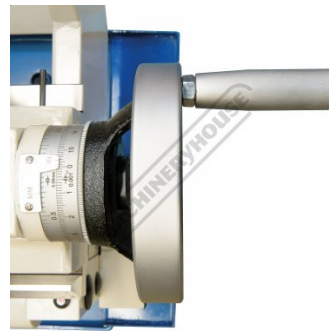

Tailstock Hand Wheel



Tailstock Quill Graduations



Tailstock Horizontal Adjustment



Hardened and Ground Bedways



Bed Drip tray



Toolbox

Recommended Accessories

L258
 Taper Turning Attachment

L277
 Vertical Mill Slide

C980
 5C Collet Lathe Adaptor

L295
 Quick Change Toolpost

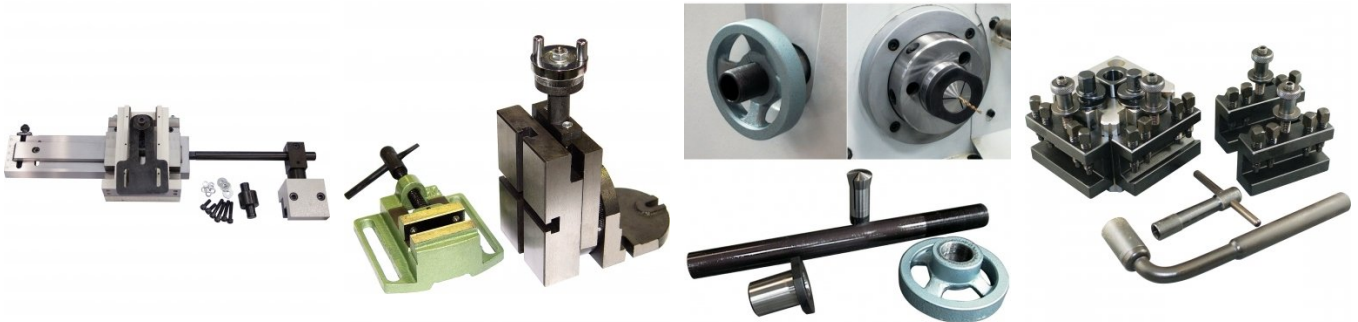

L017
 Right Hand Turning Tool Holder

L018
 Left Hand Turning Tool Holder

L044
 Right Hand Turning Tool Holder

L045
 Left Hand Turning Tool Holder

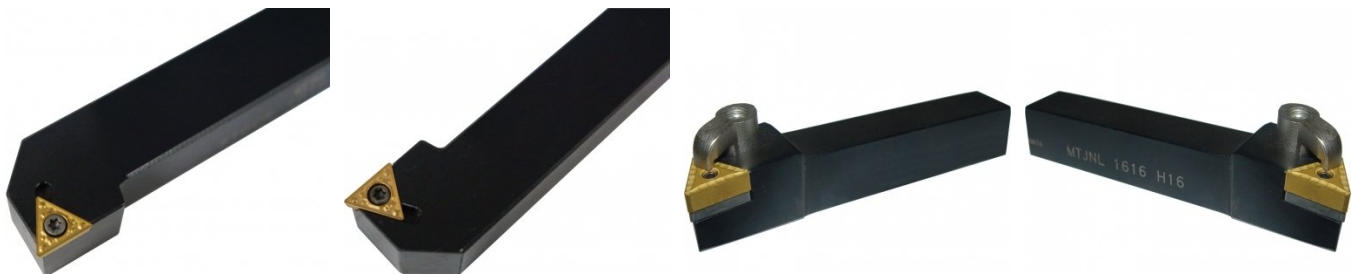

Product Brochure For L201D

L0077

Lathe Turning Tool Kit - 7 piece
Insert Type



L451

Lathe Turning Tool Kit - 3 piece
Insert Type



L457

Lathe Threading Tool Kit - Insert
Type



L465

Professional Lathe Parting Tool
Kit - Insert Type



C052

3MT Live Centre



C045

3MT Pipe Centre - 70° Cone



L076

Knurling Tool Holder Kit



C290

Heavy Duty Drill Chuck - Keyed
Type



C294

Industrial Drill Chuck - Keyless
Type



D443A

3MT x JT3 Drill Chuck Arbor



D126

Metric Precision HSS Drill Set -
170 Pieces



D1282

Imperial Precision HSS Drill Set
- 29 Piece



Product Brochure For L201D

S090A
 Soluble Metal Cutting Fluid - 1 Litre



S090
 Soluble Metal Cutting Fluid - 5 Litre



S076
 Cutting Tool Lubricant Fluid - 500ml



S077
 Drilling, Tapping & Cutting Tool Lubricant Spray - 400g



S075
 Cutting Tool Lubricant Paste - 200g



S074
 Cutting Tool Lubricant Paste - 500g



L341
 Fitting and Machining Technical Book

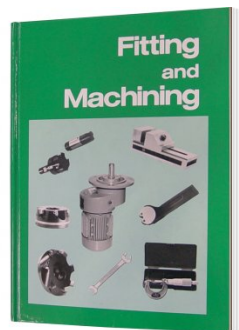

L3455
 Professional Sheet Metal Fabrication Book

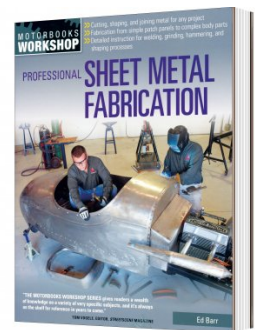

L300
 Magnetic Swarf Remover



M9991
 Magnetic Floor Sweeper



M800
 Rubber Mat - Anti-Fatigue



M805
 Rubber Mat - Anti-Fatigue

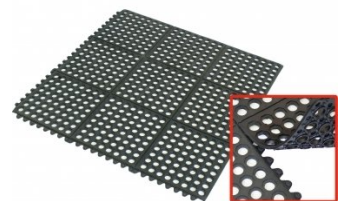

Product Brochure For L201D

O000

SpillFix Universal Organic Absorbent



O000A

Natural Zeolite Absorbent



O043

Rust & Corrosion Preventive - Penetrant & Lubrication



O042

General Purpose Lubricant & Corrosion Inhibitor



O040

Rust & Corrosion Preventive - Penetrant & Lubrication



O044

Rust & Corrosion Preventive - Penetrant & Lubrication

