

Product Brochure For S886S

APHS-31200 - Hydraulic CNC Pressbrake

200T x 3100mm, 7 Axis, Delem DA69T Touch Screen Control
 Includes Programmable X, Y1, Y2, V, Z1, Z2 & R-Axis. CNC Table
 Crowning & Laser Guarding System

Back In Stock Soon

Ex GST

Inc GST

\$158,500.00 \$174,350.00



ORDER CODE:	S886S
MODEL:	APHS-31200
Control Unit (Type):	DELEM DA69T CNC
Nominal Pressure - Tonnage (Ton):	200
Nominal Pressure - Kilonewtons (kN):	2000
Length of Work Table (mm):	3100
Distance Between Columns (mm):	2550
Throat Depth (mm):	410
Maximum Open Height (mm):	530
Ram Stroke (mm):	260
Machine Axis (No.):	7
Safety Guarding System (Type):	Laser System
Ballscrew Backgauge Travel (mm):	750
Leadscrew Backgauge Travel:	~
Table Bed Crowning System (Type):	CNC Controlled System
Motor Power (kW / hp):	18.5 / 25
Motor Voltage (V):	415
Floor Space Requirements (L x W x H) (mm):	~
Nett Weight (kg):	10000



Description

Delem DA-69T CNC CONTROL UNIT

The new generation DA-Touch controls offers an even higher grade of efficiency in programming, operation and control of today's press brakes. Ease of use combined with state-of-the-art technology go hand in hand, improving productivity.

The touch screen gives access to the proven Delem user-interface and enables direct navigation between programming and production. Functions are directly located where you need them, offering optimised ergonomics throughout the application.

The DA-69T offers 2D as well as 3D programming that includes automatic bend sequence calculation and collision detection. Full 3D machine set-up with multiple tool stations giving true feedback on the product feasibility and handling.

Highly effective control algorithms optimise the machine cycle and minimise set-up time. This makes using press brakes easier, more efficient and more versatile than ever.

- 3D and 2D graphical touch screen programming mode
- 3D visualisation in simulation and production
- 17" high resolution colour TFT
- Full touch screen control (IR-touch)
- Windows application suite
- Standard Windows networking
- 3D graphics acceleration
- Delem Modusys compatibility (module scalability and adaptivity)
- USB flash memory drive
- Open system architecture
- Sensor bending & correction interface
- Profile-T 3D offline software

Features

- Baykal machine frames are manufactured from hot rolled steel sheets of Fe 520. The two side frames are obtained from the same sheet to ensure the same elasticity under stress. The ram and table are also manufactured from Fe 520 steel and are designed to avoid deflection.
- The hydraulic cylinders are manufactured from high resistance steel chromium plated & ground to size. Cylinder pistons are lapped to ensure longevity of the hydraulic seals
- The hydraulic unit consists of electronically controlled proportional valves with independent closed loop control of the two cylinders providing full synchronous control.

Product Brochure For S886S

- German manufactured Laser Safety Guard System mounted at each end of machine ensuring correct interfacing and operator safety whilst in operation. The Laser system is designed so each guard will slide up or down to allow for many different types and sizes of tooling enabling safety at the appropriate points as required by the Australian standards. Manual height adjustment with scales and lock for easy positioning.
- Sliding front sheet supports enable a wide range of material sizes to be aligned and supported at the correct required width and height. The sheet supports are mounted on precision linear guides for ease of movement. This design can also be adjusted vertically to support material with return bends.
- Ram positions (Left & Right) are obtained from independent linear encoders whilst monitoring and adjusting proportional valves. This produces a closed loop system, with guaranteed beam positioning of +/- 0.01mm (Y1 and Y2 Axis)
- Accuracy is further ensured by mounting the linear encoders on a C-frame connected directly to the Bed, rather than the side frames. This ensures that deflection of the side frames and uneven loads have no effect on Beam position.
- CNC Controlled Axis (Y1, Y2, X, R, Z1, Z2 & V) as standard
- Backgauge:- X-R-Z1-Z2 with AC servo brushless motors
- "X" axes stroke 750mm
- "X" axis speed 350mm/sec
- "R" axes stroke 160mm
- "R" axis speed 240mm/sec
- "Z1 & Z2" combined Finger Stroke 2550mm
- Mechanical accuracy 0.1mm
- Micro adjustable fingers with hardened 2D stops mounted on linear guideways
- Precision linear scale measurement : GIVI MISURE
- Front support arms fully adjustable mounted on linear rails
- Quality Siemens Electric control switch Gear is used
- Pendant control panel centralising all Press-Brake Functions
- Foot Pedal Control
- Hydraulics: Hoerbiger & Parker (German & USA)
- Electrics: Siemens or Telemecanique (German or French)
- Scales: Misure (Italian)
- Tooling: Technostamp or Rollerli (Italian)
- Mild steel capacity is rated on hot rolled material with 250MPA

Includes

- Delem DA-69T 3D & 2D Graphical CNC Control
- Profile-T 3D offline software
- X-R-Z1-Z2 Backgauge
- V - table NC auto crowning
- Quick release top tool clamping system
- AKAS Safety laser front guarding system
- Mechanical crowning on top intermediate clamps
- Automatic crowning on bottom table
- Narrow bottom table for Euro style tooling

Specific Features



Rear Safety Guarding with Sliding Door



CNC Table Crowning W Axis



Laser Guarding System



Delem DA 69T CNC Control

Product Brochure For S886S



Delem DA 69T

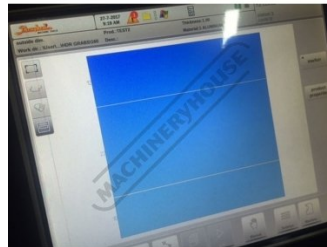

Delem DA 69T

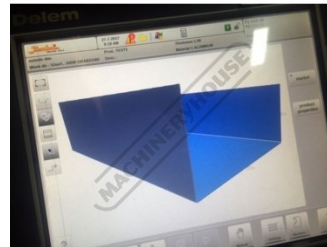

Delem DA 69T



Delem DA 69T

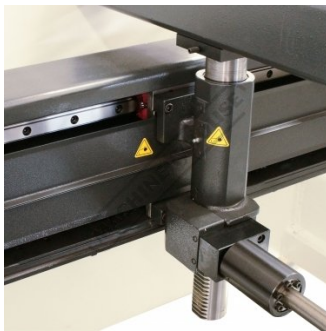

Ball Screw Backgauge with Linear Guideways



CNC Ball Screw Backgauge with R Axis

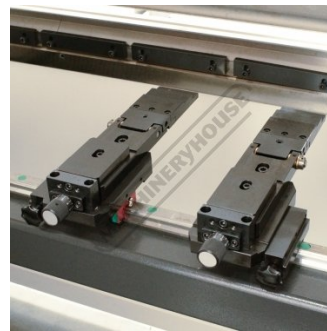

Micro Adjustment Backstop

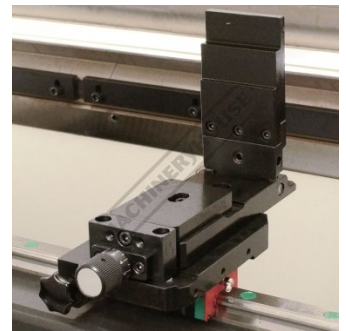

Flip up Backstop

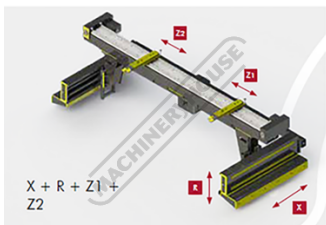

X-R-Z1-Z2 Backgauge



Quick Action Intermediate Clamps



Sliding Front Sheet Supports on Linear Guideways



Front Sheet Support Height Adjustment

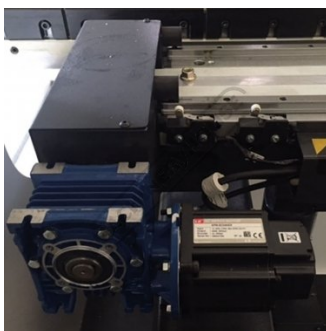

Z1 Z2 Backgauge fingers servo system



Servo driven Universal Backgauge Fingers



Mobile Foot Control

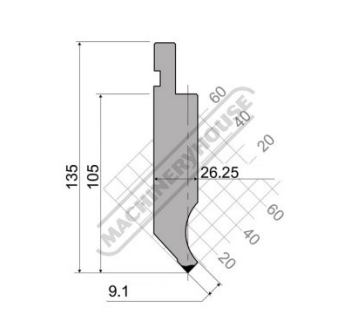

Top Tooling

Product Brochure For S886S

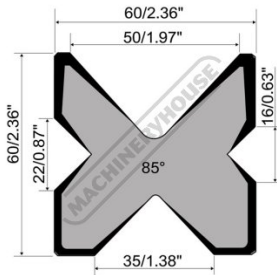

Multi V Die Block

Recommended Accessories

Z30596
 100mm Die Block Pressbrake
 Tooling

Q200
 Combination Set

Q200A
 Combination Set

Q201
 Universal Bevel Protractor

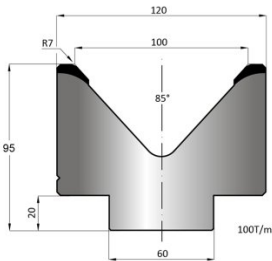

M800
 Rubber Mat - Anti-Fatigue

M805
 Rubber Mat - Anti-Fatigue

O000A
 Natural Zeolite Absorbent

O043
 Rust & Corrosion Preventive -
 Penetrant & Lubrication

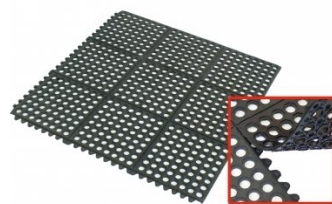

Product Brochure For S886S

O042

General Purpose Lubricant & Corrosion Inhibitor



O040

Rust & Corrosion Preventive - Penetrant & Lubrication



O044

Rust & Corrosion Preventive - Penetrant & Lubrication



O004

Superdraulic 46 Hydraulic Oil

