

BMSY-540-CGH - Semi Automatic Double Column & Swivel Head Band Saw

750 x 540mm (W x H) Rectangle Capacity

Ex GST **Inc GST**
\$41,500.00 **\$45,650.00**



ORDER CODE:	B141
MODEL:	BMSY-540-CGH
Operation Type:	Swivel Head & Semi - Automatic
Round @ 90° (mm):	540
Round @ 45° (mm):	510
Round @ 60° (mm):	270
Square @ 90° (mm):	540
Square @ 45° (mm):	450
Square @ 60° (mm):	250
Rectangle (W x H) @ 90° (mm):	750 x 540
Rectangle (W x H) @ 45° (mm):	450 x 540
Rectangle (W x H) @ 60° (mm):	250 x 540
Coolant System:	Yes
Table Working Height (mm):	695
Cutting Head Beam Type:	Semi-Automatic
Cutting Head Beam Return:	Auto-Hydraulic Return
Cutting Head Down Feed Control:	Adjustable Hydraulic
Vice Clamping Fixture:	Automatic-Hydraulic
Bundle Cutting Fixture:	Optional
Blade Steps / Speeds (m/min):	Variable 20-100
Blade Size (L x W x T) (mm):	6000 x 41 x 1.3
Motor Power (kW / hp):	4 / 5.5
Voltage / Amperage (V / amp):	415
Nett Weight (kg):	2445



Description

Manufactured in Turkey

BMSY-540-CGH SWIVEL HEAD, DOUBLE COLUMN, METAL CUTTING BAND SAW (415V)

Features

- Swivel head for mitre cutting up to 60°
- 2° blade incline for improved cutting
- Inverter variable blade speed control
- Material height sensor for beam to rapid down and start cut feed rate when reached material
- Digital readout display for accurate mitre cutting
- Head mitre hydraulic brake locking system
- Linear guide ways for improved accuracy
- 500mm high vice jaws for increased clamping area
- Auto optical material height adjustment
- Sensitivity cutting pressure dial
- Blade cover safety interlock switches
- SITI industrial duty gearbox drive
- SAP coolant pump system
- Saw blade cleaning brush

Includes

- Laser liner material pointer
- Hydraulic material top clamp
- Hydraulic blade tension device

Optional Accessories

- Motorised in/out feed roller conveyor system

Product Brochure For B141

Specific Features



Front View With Head Fully Down



Front View Vice Fully Open



Swivel Head To 60 Degrees



Swivel Head To 60 Degrees Right View



Swivel Head To 60 Degrees Side View



Rear View Swivel Head To 60 Degrees Left View



Rear View Swivel Head 60 Degrees



Side View



Rear Left View

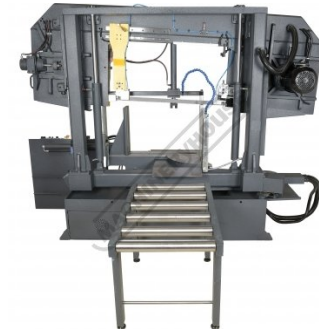

Rear View With Roller Conveyor



Rear View Head Up



Rear View Head Down



Laser Line Pointer

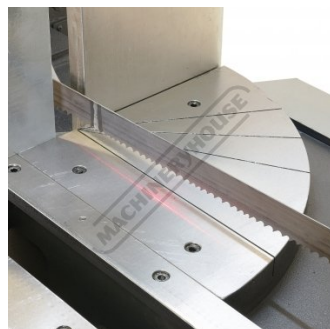

Laser Line Material Pointer Shown



Laser Line Material Pointer



Head Lock Switch With Digital Mitre Angle

Product Brochure For B141



Control Panel



Pressure and Sensitivity Feed Controls

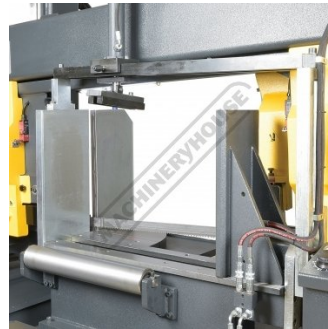

Clamping Area



500mm High Vice Jaws



500mm High Vice Jaws Left View

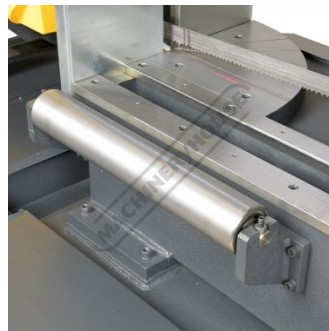

Heavy Duty Material Roller

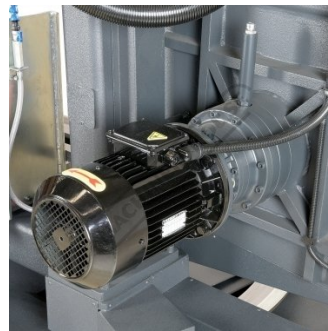

Heavy Duty Motor and Gearbox



Coolant Hose



Blade Cleaning Brush



Blade Cover With Interlock Switches



Safety Micro Switch On Blade Guards



Heavy Duty Blade Guides



Hydraulic Material Clamping



Hydraulic Material Clamping 2



Hydraulic Vice



Hydraulic Top Clamp

Product Brochure For B141



Automatic Hydraulic Clamping



Hydraulic Material Top Clamp



Hydraulic Top Clamp Position Clamp



Cutting Table Angle Slots



Linear Guide Ways for Improved Accuracy



Linear Guide Ways On Posts



Adjustable Blade Guide



Auto Optical Material Height Adjustment

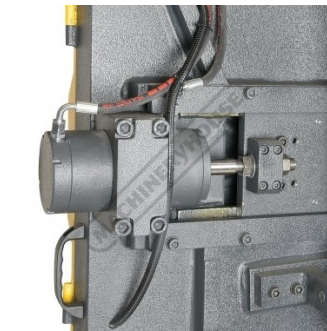

Hydraulic Blade Tension

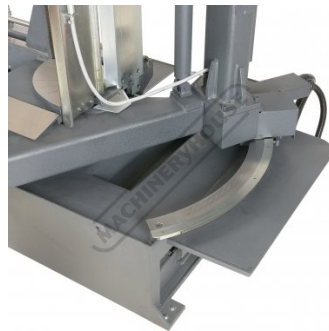

Swivel Head Slide

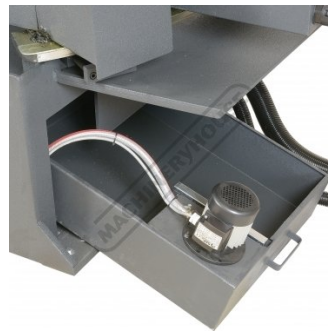

Coolant System Pull Out Tray



Work Light



Roller Conveyor

Product Brochure For B141

sales@machineryhouse.com.au
 www.machineryhouse.com.au

Recommended Accessories

B623

Metal Band Saw Blade - 2-3TPI
 Bi-Metal, Blade - 6000 x 41 x
 1.3mm



B624

Metal Band Saw Blade - 3-4TPI
 Bi-Metal, Blade - 6000 x 41 x
 1.3mm



B625

Metal Band Saw Blade - 4-6TPI
 Bi-Metal, Blade - 6000 x 41 x
 1.3mm



W3434

Roller Stand



W3436

Roller Stand - V-Type



W343A

Roller Stand



W343

Roller Stand



S090A

Soluble Metal Cutting Fluid - 1
 Litre



Product Brochure For B141

S090

Soluble Metal Cutting Fluid - 5 Litre



S076

Cutting Tool Lubricant Fluid - 500ml



S077

Drilling, Tapping & Cutting Tool Lubricant Spray - 400g



S075

Cutting Tool Lubricant Paste - 200g



S074

Cutting Tool Lubricant Paste - 500g



S091

Soluble Metal Cutting Fluid - 20 Litre



L300

Magnetic Swarf Remover



M9991

Magnetic Floor Sweeper



L812

Roller Conveyor



L816

Roller Conveyor Stand



M800

Rubber Mat - Anti-Fatigue



M805

Rubber Mat - Anti-Fatigue

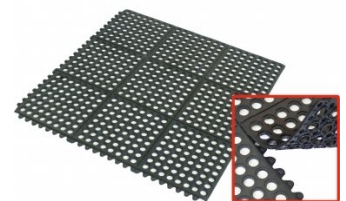

Product Brochure For B141

O000

SpillFix Universal Organic Absorbent



O000A

Natural Zeolite Absorbent



O043

Rust & Corrosion Preventive - Penetrant & Lubrication



O042

General Purpose Lubricant & Corrosion Inhibitor



O040

Rust & Corrosion Preventive - Penetrant & Lubrication



O044

Rust & Corrosion Preventive - Penetrant & Lubrication

